



IPA 2010 program Europske unije za Hrvatsku / The European Union's IPA 2010 Programme for Croatia

Poboljšanje sustava ovrhe u Republici Hrvatskoj

Improvement of the Enforcement system in the Republic of Croatia

Activity 2.2.3

Preparing cost benefit analysis of enhancing IT interconnectivity and interoperability in line with the recommendations produced through activity 2.2.2



Improvement of the Enforcement system in the Republic of Croatia
 Contract Number: 2010-01-23-010101
 Twinning Number: HR/10/IB/JH/04



THE EUROPEAN UNION'S 2010 PROGRAMME

Twinning Ref. Number HR/10/IB/JH/04

Consortium: Spanish Ministry of Justice/Hungarian Ministry of Justice
 /Croatian Ministry of Justice/FIIAPP

INDEX

PRECEDENTS	6
1 EXECUTIVE SUMMARY	7
2 SCOPE OF THE ACTIVITY	9
3 METHODOLOGY	9
4 COST BENEFITS ANALYSIS INPUTS	10
4.1 AREAS OF IMPROVEMENT	10
4.2 STATISTICAL INFORMATION AND ASSUMPTIONS	10
4.3 SCENARIO 1 – ENFORCEMENT OVER MONETARY ASSETS	12
4.4 SCENARIO 2 – ENFORCEMENT ON IMMOVABLE ASSET	14
5 EXECUTION OF THE COST BENEFIT ANALYSIS	15
5.1 SCOPE A ANALYSIS	15
5.1.1 PROJECTS COVERED	15
5.1.1.1 Electronic Services	16
5.1.1.2 Systems, Technical Platforms and Applications	18
5.1.1.3 Policies and IT Strategy	19
5.1.1.4 Stakeholders	21
5.1.2 BENEFIT ANALYSIS	22
5.1.2.1 Scenario 1 – Enforcement over monetary assets	25
5.1.2.2 Scenario 2 – Enforcement on immovable	27
5.1.3 COSTS ANALYSIS	29
5.2 SCOPE B ANALYSIS	33
6 CONCLUSIONS	35



Improvement of the Enforcement system in the Republic of Croatia

Contract Number: 2010-01-23-010101

Twinning Number: HR/10/IB/JH/04

ILLUSTRATIONS AND TABLES

Table 1 – Number of enforcement over immovable assets, monetary claims, movables and others per year	11
Table 2 – Assumptions for estimation of savings	11
Table 3 – Number of enforcements over monetary assets per year	11
Table 4 – Assumptions for estimation of savings	12
Illustration 5 – Scenario 1 - Enforcement over monetary assets	12
Illustration 6 – Scenario 2 – Enforcement on immovable assets	14
Table 7 – Benefits and Electronic Services.....	18
Table 8 – Benefits and System, Technical Platforms and Applications	19
Table 9 – Benefits and Policies and IT Strategy	21
Table 10 – Benefits and Stakeholders.....	22
Illustration 11 – Scenario 1 - Enforcement over monetary assets.....	25
Illustration 12 – Scenario 2 – Enforcement on immovable.....	27
Table 11 – Scope A project status.....	30



Improvement of the Enforcement system in the Republic of Croatia

Contract Number: 2010-01-23-010101

Twinning Number: HR/10/IB/JH/04

GLOSSARY

For the purpose of this report, the following terms should be understood as follows:

Civil Law: the body of laws of a state or nation dealing with the rights of private citizens.

Court: a place where justice is administered or a judicial tribunal duly constituted for the hearing and determination of cases.

Judicial decisions/judicial resolutions: a verdict, judgment, conclusion reached or given by a court or tribunal.

Enforcement: to compel observance or obedience to something, in this case, judicial decisions/judicial resolutions and arbitration award.

Auction: a sale open to the general public and conducted by an auctioneer, a person empowered to conduct such a sale, at which property is sold to the highest bidder.

Bid: an offer by a bidder, a prospective purchaser, to pay a designated amount for the property on sale.

Appraisal: a valuation of property or goods.

Edict: a proclamation having the force of law.

Warrant: an amount of money considered as having the force of a guarantee or as being positive assurance for an auction.

Court Solicitor: the public officer in a county, district, or other jurisdiction charged with carrying on the prosecution in criminal proceedings.

Court Attorney: an officer of the court authorized to appear before it as a representative of a party to a legal controversy.

Lawyer: a person whose profession is to represent clients in a court of law or to advise or act for clients in other legal matters.

Claim: a demand claimed in a formal or legal manner.

Electronic Judicial Office: portal which gathers all the e-justice services.

Capex: capital expenditure, is a business expense incurred to create future benefit. For example, a business might buy new assets, like buildings, machinery, or equipment, or it might upgrade existing facilities so their value as an asset increases.

Opex: operational expenditure, is the money the business spends in order to turn inventory into throughput. These are the expenditures required for the day-to-day functioning of the business, like wages, utilities, maintenance, and repairs, etc.



Improvement of the Enforcement system in the Republic of Croatia
Contract Number: 2010-01-23-010101
Twinning Number: HR/10/IB/JH/04

ABREVIATONS

FINA	Croatian State Agency responsible for the financial intermediation
STE	Short Term Experts
LFEP	Public Statistical Services
OIB	Croatian Personal Identification number
ICMS	Integrated Case Management System
CBA	Cost Benefit Analysis
IPA	Instrument for Pre-Accession Assistance
eIDAS	Electronic identification and trust services
MoJ	Ministry of Justice



Improvement of the Enforcement system in the Republic of Croatia

Contract Number: 2010-01-23-010101

Twinning Number: HR/10/IB/JH/04

Precedents

This Project is based on three basic commitments of Croatia's Treaty of Accession to the European Union in 2008:

1. To reduce the number of unsettled cases in the courts.
2. To simplify the organization of courts and tribunals.
3. To guarantee the correct enforcement of judicial sentences.

Since 1996 when the "Enforcement Act" came into effect, and for the attainment of the mentioned aims, Croatia has made important legislative reforms. Among the above mentioned reforms, the most significant took place in 2012, when the possibility of the direct enforcement of the judicial decisions, judicial resolutions or arbitration award was established by means of seizure of bank accounts through the Croatian State Agency responsible for the financial intermediation (FINA).

Some of the positive effects of these reforms were mentioned in the follow-up report on the proceedings of the accession process of Croatia, from March 26, 2013. Nevertheless greater efforts are still necessary to reduce the case backlogs in the courts, which remain higher than the European average.

The most recent reforms of the "Enforcement Act", named "Act of Amendments to the Enforcement Act", were carried out in December, 2013 and July, 2014, and came into force in September 1st, 2014. Nowadays, a new amendment from January 2014 on the sale of personal property and real estate in the enforcement procedure is in the Parliament.

The aims of this Project are to provide the necessary technical assistance to courts, public notaries and the FINA, in order to extend and to reinforce its jurisdiction, simplify the enforcement procedures and increase the citizens' knowledge of the system of enforcement.

The purpose of the 2.2.2 assistance is to conduct screening of the IT system used in the Republic of Croatia regarding enforcement system in stakeholders' institutions and relevant public administrative bodies.

Following this screening, a report with recommendations on at least two models that could be applied to improve the Croatian enforcement system was delivered.

The assistance is focused on technical aspects and includes the analysis of IT structure and business processes from IT point of view.

Two work groups formed by two technical experts from Spain and two technical experts from the BC will develop an in-deep analysis of the Croatian IT systems, with special emphasis to IT systems supporting enforcement and legal communication with stakeholders.

Final report of activity 2.2.1 will be taken into account.



1 Executive Summary

DEBRIEFING REPORT EXECUTIVE SUMMARY	
Experts	<p>Mr José Luis Hernández Carrión <i>Associate Deputy General Director of New Technologies of Justice. Ministry of Justice</i> <i>Member of Technical State Committee of Judicial Electronic Administration</i></p> <p>Mr Jesús Barba Lobatón <i>Chief of Area of Technology Innovation and Platforms of the New Technologies of Justice.</i> <i>Ministry of Justice</i></p>
Mission	Preparing cost benefit analysis of enhancing IT interconnectivity and interoperability in line with the recommendations produced through activity 2.2.2
Dates	April 20-24, 2015
Places	Zagreb
Objectives	<p>MS STEs will organize a workshop to analyse two models, proposed through activity 2.2.2, and prepare a cost benefit analysis of enhancing IT interconnectivity and interoperability. This cost benefit analysis will take into consideration both costs and advantages and disadvantages of developing and implementation of certain system in the Republic of Croatia, expected life span and benefits.</p> <p>Moreover, the cost benefit analysis will provide information on the best solution for domestic enforcement system to be applied.</p> <p>MS STEs will make a report with final conclusions including cost benefit analysis.</p>
Methodology	<p>The cost benefit analysis (CBA) will be done following these steps:</p> <ol style="list-style-type: none"> 1. To determine the cost benefit analysis inputs. 2. To define the scenarios and indicators linked to the areas of improvement. 3. To run CBA. 4. Conclusions.
Outcomes	Final report with conclusions and recommendations
Conclusions	<p> The use of e-Justice services implies a radical change of the way how Justice Administration interacts with citizens, legal</p>



DEBRIEFING REPORT EXECUTIVE SUMMARY

professional, companies and other public administration. Furthermore, this change of paradigm also affects the Justice Administration work system, changing the current model based in paper files, use of mail and in-court paperwork to a new model based on electronic documents and files, data-oriented and Internet-enabled services.

The benefits of the effective deployment of new e-Justice services and systems imply a significant improvement in the Croatian Enforcement system. This benefits can be measured in several dimensions, such as:

Functional: e-Justice services change the relationship model towards a citizen-and companies-oriented justice. The justice users are empowered, so they can establish a completely different relationship model with the Justice Administration. With the implementation of a real e-Justice, the Administration of Justice would become a key driver of innovation for the whole Croatian Public Administration.

Economic: The change of the current enforcement model requires large investments to develop new systems, to develop adequate IT infrastructure, to train the courts staff, etc. Most of the projects identified in scope A would be covered with IPA 2012 and the remaining projects require an estimated development effort estimated in around 2.000 man/days. Despite this important investment required, there are important compensations. It has been estimated that applying e-justice services to the civil enforcement could save 236 million of HRK per year in two defined scenarios. so the return of investment is clearly justified

An innovative Justice improvement would allow providing new services to other Croatian public administrations and private sector, so they could deliver public services based on cost-effective, internet enabled, agile, secure, high quality and citizens-oriented that would boost not only the enforcement or the Justice administration, but also economic sectors.

Annexes



20150420 - Activity
2 2 3 - Statistics and

Estimation spreadsheet



2 Scope of the activity

The mission 2.2.3 set as objectives the cost benefit analysis of enhancing IT interconnectivity and interoperability taking into consideration costs as well as advantages and disadvantages. Despite the fact that the activity has been implemented in five working days instead of ten, the technical assistance has achieved the goals of the workplan and the terms of reference. Instead of a work shop, two meetings were held with representatives of the IT Department of the BC in order to determine which one of the two models proposed under mission 2.2.2 should be analysed in detail. It is worth pointing out that those two models are complementary, defined as the phases of the roadmap necessary to accomplish an actual e-justice system.

For this mission 2.2.3 the final report would cover:

- An analysis of both models, specifying how each model contributes to improve the Judicial System. In the meetings with the Ministry of Justice it has been agreed to focus the efforts on scope A. Scope B has been described; but neither the benefits nor the cost has been estimated. However as scope A and B are complementary, all the cost and benefits of scope A shall apply to scope B.
- Benefits and cost of scope A.
- A rough estimation of cost of projects not included in IPA 2012 based in the Spanish experience in similar projects. The cost will be indicated in hours of effort per profile.

3 Methodology

The cost benefit analysis (CBA) will be done following these steps:

1. To determine the cost benefit analysis inputs.
2. To define the scenarios and indicators linked to the areas of improvement.
3. To run CBA.
4. Conclusions.

During the activity 2.2.3, the following meetings have taken place:

Data and Time	22/04/2015 10:00	Location	Room 618 - Ministry of Justice Ulica grada Vukovara 49 Zagreb
Attendants	<p>Ministry of Justice</p> <p>Ms Tatjana Pinhak (Advisor to the Minister for IT)</p> <p>Mr Silvije Šeremet (Senior IT Advisor)</p> <p>Ms Tanja Magdić (IT Department)</p> <p>Twinning Project</p> <p>Ms Marián Oyola Reviriego (Resident Twinning Advisor)</p> <p>Mr Jose Luis Hernández Carrión (Short Term Expert)</p>		



	Mr Jesús Barba Lobatón (Short Term Expert)
Summary	Review of the activity 2.2.2 report with the MoJ IT direction board and determined which of the models proposed is to be analyzed in activity 2.2.3

Data and Time	23/04/2015 10:00	Location	Room 618 - Ministry of Justice Ulica grada Vukovara 49 Zagreb
Attendants	Ministry of Justice Ms Tanja Magdić (IT Department) Twinning Project Ms Marián Oyola Reviriego (Resident Twinning Advisor) Mr Jose Luis Hernández Carrión (Short Term Expert) Mr Jesús Barba Lobatón (Short Term Expert)		
Summary	Review of MoJ comments on the activity 2.2.2 report.		

4 Cost Benefits Analysis Inputs

4.1 Areas of improvement

The CBA will take into consideration the actions that should be taken in following areas of improvement (identified in 2.2.2 activity):

1. Massive use of paper.
2. E-Justice services organization.
3. To increase e-Justice services availability.
4. Boost system integrations.
5. To increase and expand the use of Digital Signature.
6. To promote interoperability plans.

These areas of improvement are detailed in the section “4.2 State-of-Play Overview” of the mission 2.2.2 final report.

4.2 Statistical Information and assumptions

To model the benefits of the actions implemented, the statistical data from first semester of 2014 regarding the enforcement process in Croatia has been used. In order to provide data per year, this statistics have been projected to a whole year. The figures are the following:

- Number of enforcement over immovable assets, monetary claims, movable assets and others per year.



Improvement of the Enforcement system in the Republic of Croatia

Contract Number: 2010-01-23-010101

Twinning Number: HR/10/IB/JH/04

PROCEEDINGS RECEIVED	
INNMOVABLE ASSETS	16.182
MONETARY CLAIMS	76.810
MOVABLE ASSETS	18.412
OTHER	15.838
	127.242
PROCEEDINGS SOLVED	
INNMOVABLE ASSETS	16.556
MONETARY CLAIMS	83.342
MOVABLE ASSETS	20.594
OTHER	16.784
	137.276
PROCEEDINGS PENDING	
INNMOVABLE ASSETS	57.332
MONETARY CLAIMS	42.072
MOVABLE ASSETS	52.618
OTHER	11.920
	163.942

Table 1 – Number of enforcement over immovable assets, monetary claims, movables and others per year

For this type of enforcement the following assumptions have been made. This information has been estimated with the support of Ministry of Justice staff:

Document per Process	10
Pages per Document	10
Cost per Page (including paper, toner, archive cost)	0,50kn
Debtor and Creditor's visit to court per procedure	3
Copies of the Judicial File per process	2
Cost of each copy of the Judicial File	50,00kn
Hours per visit	1
Cost of hour (assuming the Croatian minimum wage published by Eurostat in 2015)	17,05kn
Number of notifications per Process	6
Estimated cost of each notification	50,00kn

Table 2 – Assumptions for estimation of savings

Number of enforcement over monetary assets per year

PROCEEDINGS RECEIVED	1.435.870
PROCEEDINGS SOLVED	702.984
PROCEEDINGS PENDING	732.886

Table 3 – Number of enforcements over monetary assets per year

For this type of enforcement the following assumptions have been made. This information has been estimated with the support of Ministry of Justice staff:

Document per Process (debtor request)	2
Pages per Document	4
Cost per Page (including paper, toner, archive cost)	0,50kn
Debtor and Creditor's visit to FINA per procedure	1
Copies of the Enforcement File per process	2



Cost of each copy of the Judicial File	4,00kn
Hours per visit	0,5
Cost of hour (assuming the Croatian minimum wage published by Eurostat in 2015)	17,05kn
Number of notifications per Process	2
Estimated cost of each notification	50,00kn

Table 4 – Assumptions for estimation of savings

4.3 Scenario 1 – Enforcement over monetary assets

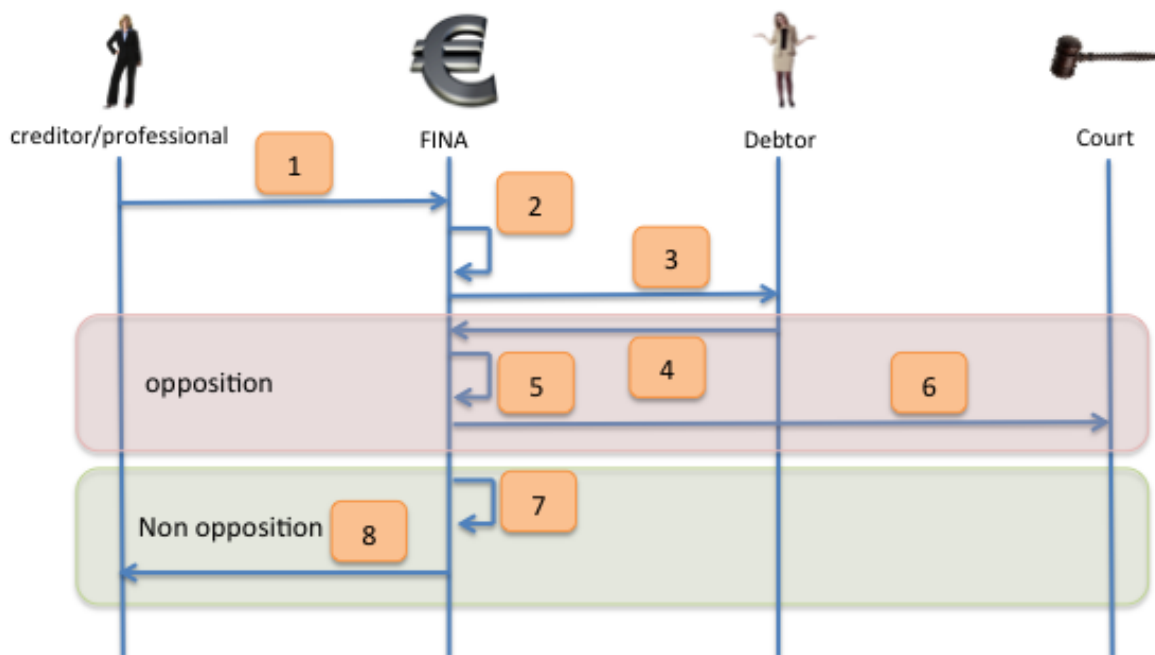

Illustration 5 – Scenario 1 - Enforcement over monetary assets

1. Creditor files for enforcement on the grounds of court/notary enforceable document. This request is done in paper format.
2. FINA seizes the debtor bank account, if any, for the amount of the debt.
3. FINA notifies the debtor, by means of paper, that the enforcement is going to take place. The debtor can file an opposition.
4. If the debtor files for opposition, he/she may provide documents for evidence.
5. FINA closes the enforcement request.
6. The file, in paper, is sent to Municipal Court. This file is sent in paper form.
7. FINA, at the request of the debtor, seizes the amount of money requested in the enforcement request.
8. FINA notifies the creditor, by means of paper, the result of the enforcement procedure and closes the file. This notification is performed in paper format.



Improvement of the Enforcement system in the Republic of Croatia
Contract Number: 2010-01-23-010101
Twinning Number: HR/10/IB/JH/04



4.4 Scenario 2 – Enforcement on immovable asset

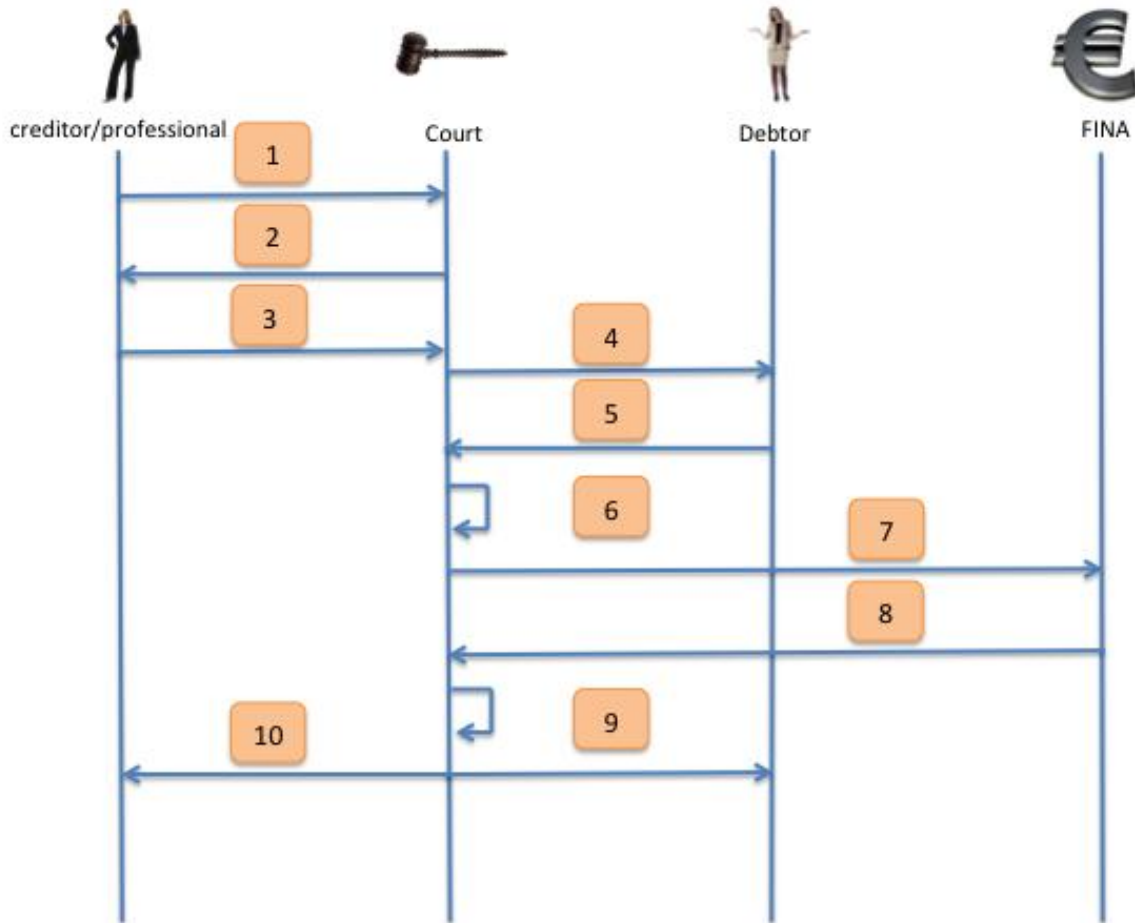

Illustration 6 – Scenario 2 – Enforcement on immovable assets

1. In order to collect his debt, the creditor must provide a Land Registry extract. This extract has to be requested using paper means. However, the Ministry of Justice is working on an electronic service, which is estimated to be in production in short term.
2. The Land Registry office generates the extract in paper format and provides it to the citizen. In case the electronic service is made available, the land registry will have opportunity to send the extract through e-Citizen portal. The provided extract will include a digital signature and a secure verification code, so the creditor is able to download it and print it.
3. Creditor demands enforcement on the grounds of court/notary enforceable document. This request comprehends the motion for enforcement and the extract, both in paper. This notification is performed by means of paper.
4. Court notifies the debtor that there is an on-going enforcement process. This notification is performed in paper form.
5. The debtor has the chance to oppose, providing supporting documents. These documents must be submitted to the court in paper form.
6. The court follows the procedure and makes the decision about the auction.
7. The court sends the necessary information to FINA in order to perform the electronic auction. This part of the file is sent to and registered in FINA in paper form.



Improvement of the Enforcement system in the Republic of Croatia

Contract Number: 2010-01-23-010101

Twinning Number: HR/10/IB/JH/04

8. FINA conducts the auction and notifies the court the best bid and who is the buyer. Notification is, again, in paper form.
9. The court takes the necessary steps to finish the enforcement proceedings.
10. Court notifies creditor and the debtor in paper form the result of the action and the amount of adjudication.

5 Execution of the Cost Benefit Analysis

As it was highlighted in the previous mission report (mission 2.2.2), it is possible to achieve two different scopes to improve the civil enforcement system in the republic of Croatia. Those are scope A and scope B, which pursue to achieve the same objective, but they differ in the level of compliance.

In this section both scopes will be analysed to be able to determine which one fits better in the current situation of the Republic of Croatia, taking into account economic, political and opportunity aspects.

During the meetings held with the Ministry of Justice, it was agreed to focus the cost-benefit analysis on scope A which is more feasible in time than scope B, which is more ambitious. Scope A analysis will be executed in detail. Scope B will not be analysed in detail, the efforts will focus on detailing the benefits of each project. However, as scope A and B are complementary, all the cost and benefits of scope A apply to scope B.

5.1 Scope A Analysis

Scope A covers the basic aspects required to evolve the current judicial process to an e-Justice system, including the enforcement process. The goal is to achieve a minimum set of capabilities to allow an electronic judicial system to be able to offer electronic services of e-Justice. These services are not provided only to internal IT departments, but also to courts, citizens, other public administrations and legal professionals. The developments of the proposed projects benefits are focused on improving the Civil Enforcement System in the Republic of Croatia. These benefits are not only confined to enforcement; they are also extensible to the complete Justice Administration taking into account the necessary adaptations.

5.1.1 Projects covered

During the Scope A analysis, each project benefit will be highlighted, listing in detail the main ones. The analysis of the thirteen projects is divided into four action plans established in the activity 2.2.2 report:

- **Electronic Services.** Set of services Internet-enabled services oriented to establish easier and more agile/quicker relationships between citizens and legal professionals and the Justice Administration. These kinds of projects offer a final service to a citizen, professional or Public Administration.
- **Systems, Technical Platforms and Applications.** This action plan is focused mainly on the IT department, more than on the end user. An exception to this group is the Digital Signature platform, which is also used by external users like key aspect of the Electronic Judicial Administration. It is intended for building modular and resilient applications. The use of reusable components is a key factor to reduce the applications time-to-market, to reduce development and maintenance cost.
- **Policies and IT Strategy.** This action plan gathers all the regulation related projects: legal, organizational, semantic and technical regulations. Therefore, in this section, aspects of legal



Improvement of the Enforcement system in the Republic of Croatia

Contract Number: 2010-01-23-010101

Twinning Number: HR/10/IB/JH/04

regulation, as the need for a comprehensive Act on Electronic Justice Administration, but also specific regulations for the Interoperability Framework or the Digital Signature shall be included.

- **Stakeholders.** Third parties must be involved in the transformation process in order to reach a modern justice administration, as without their participation it is not possible to get most of the benefits identified in this report. Citizens, legal professionals and other administrations must be principal and active actors in the transformation process.

5.1.1.1 Electronic Services

- **eFiling:** This service allows sending digitally signed writings and documents to courts in electronic format. This project has two different parts: an end-user oriented portal and the back office system. The first one is focused on end users; those are citizens, legal professionals and Public Administrations. This should be developed as an Internet-enable web application and should be capable to route a message from a third party to a specific court. Therefore the system has to be connected with all possible courts as destinations. The back office subsystem is designated to process the received messages and incorporate them into the ICMS, so the messages would be available to the court. The most important security aspects to be considered are authenticity, confidentiality, integrity and availability of the messages. All of them should be solved with the use of a digital signature performed by the end user. The user should sign the documents and also the 'electronic envelop'. Regarding the tax payment, different e-Tax solutions (ad-hoc complete system or a mixed system with development integrated with existing electronic banking solutions) could complement this solution enabling a complete eFiling process.
- **eDelivery:** this system is also compounded by two subsystems: a web front end for the users and a backend for the integration with the ICMS. The goal of this system is to send legal and valid notifications to citizens and legal professionals, avoiding the use of paper. It is strongly recommended to integrate this eDelivery system with the ICMS. The messages sent by this system are composed of at least an address and one document. The second part of the system is an end-user oriented electronic service available for citizens, legal professionals and Public Administrations. In this case, an additional security aspect must be added respecting the previous service: the non-repudiation aspect. When a court sends a message to a citizen, legal professional or Public Administration, the most important thing to know is when the recipient has accessed the notification. Therefore it is not useful to use the commercial solutions like outlook.com, gmail.com, etc., as mailboxes because it is necessary to have a solution capable to "sign" the timestamp when the notification has been accepted and opened due access control is required to manage the legal deadlines. In conclusion, customized solution for the Ministry of Justice must be developed in order to solve the handicap of the non-repudiation dimension.
- **Secure Code Verification:** to print a digitally signed electronic document is a regular requirement of the user. As the signature is digital, a solution to assure the integrity and authenticity of the document is required. That situation could become a problem if the appropriate technical tools are not available. Meanwhile the original document remains in electronic format; with the digital signature attached to the document it is a sufficient mechanism to validate the authenticity and integrity. But if the document has been printed those mechanisms are lost. Therefore in order to give citizens and legal professionals a tool to verify the authenticity of the received documents, the Secure Verification Code should be implemented for all those documents generated by the Public Administration, which are susceptible to be printed by stakeholders during the document lifecycle. The Secure Code Verification is a code generated individually for each document and included in



such document. Once the original electronic document has been printed and the digital signature capabilities have been lost, the Secure Verification Code only remains printed in paper. With that code, the document recipient is able to verify it by introducing the code in the Electronic Judicial Office, download the original electronic file and verify the printed-paper with the electronic version. In this scenario original electronic documents can be printed but can be verified in the Electronic Judicial Office, without losing the authenticity and integrity.

- Judicial Case Status:** whereby citizens and legal professionals could access to their cases and check their current status. This is probably the most demanded service by citizens and legal professionals nowadays, as it allows to users to check how their cases are going on from any computer at any time. This electronic service allows users to reduce significantly number of visits to court as they can check the status of cases online. Also it could be confirmed with an email, SMS or e-Citizen portal communication each time a status change has occurred. In this case, it would be a communication, instead of notification, just for information process with no legal value.

In the following table projects of electronic services group have been matched with the fourteen benefits identified in this scope:

		Electronic Services			
		eFiling	eDelivery	Secure Code Verification	Judicial Case Status
Benefits	Paper reduction	✓	✓		✓
	Agility	✓	✓		✓
	Displacement reduction	✓	✓	✓	✓
	Security	✓	✓	✓	
	Availability	✓	✓	✓	✓
	Interoperability	✓	✓	✓	✓
	Data integrity	✓	✓	✓	
	Better regulation ¹				
	Document lifecycle optimized	✓	✓	✓	
	Extensibility to the society	✓	✓		✓
	Cost reduction	✓	✓	✓	

¹ Regulation which clearly defines and provides for the use of IT in the judicial system.



Improvement of the Enforcement system in the Republic of Croatia

Contract Number: 2010-01-23-010101

Twinning Number: HR/10/IB/JH/04

Shorter deadlines	✓	✓	✓	
	Shorter time to implement the projects ²			
	✓	✓		
Statistics				

Table 7 – Benefits of Electronic Services

5.1.1.2 Systems, Technical Platforms and Applications

- Digital Signature:** is a basic element of the judicial electronic administration to be able to assure and include authentication, confidentiality, integrity, availability, non-repudiation and time-stamping capabilities to the judicial documents and data, and in relationships with citizens, legal professionals and other Administrations. Before the documents of the procedures obtain electronic format, by attaching digital signatures, the format of the signature to be used in each case should be defined. The most usual format used nowadays for this kind of documents where the recipient could be a citizen or a legal professional is PAdES. PAdES (PDF Advanced Electronic Signatures); it is a set of restrictions and extensions to PDF and ISO 32000-1 making it suitable for advanced electronic signature. This is published by ETSI as TS 102 778.

To support digital signature deployed in the organization for internal and external users, it must be covered by a PKI (Public Key Infrastructure). This PKI must be available with all needed parts: Certification Authority, Registration Authority and Validation Authority. As far as it can be researched during this activity, the unique PKI available right now in the Republic of Croatia is FINA.

- Document Management:** incorporated to the IT Infrastructure is able to manage the Corporation's document library. Used to manage the flow of all types of documents in the organization, allows recovery of information from them, determines the time that the documents should be stored, removes those which are no longer needed and assures the long-term preservation of valuable documents, etc. Focusing on enforcement process, all the electronic documents of enforcement cases must be stored on this platform, which provides searching, indexing, resealing capabilities and prevents the leakage of information.
- Master Data Repository:** This system contains all the applications on the shared set of data. All the applications should reference this repository for shared data as master data instead of using their own. This is one of the most important elements when the organization wants to achieve a full interoperability among a complex set of internal and external systems. It is strongly recommended to implement a master data repository and make it available to all applications and systems via direct access to the tables, web services published on the ESB, etc. In the Enforcement process

² Based on the philosophy of reutilization of services and components, the time required between the definition of the project and the go-live should be significantly reduced.



scenario, there are a lot of data to be exchanged: financial information, personal information, land registry information, etc. It is necessary to assure that every involved system uses the “same language” in order to achieve a complete and useful semantic interoperability. Codes such courts codification, police offices, legal professionals, id numbers etc. are values susceptible to be included in this system.

		Systems, Technical Platforms and Applications		
		Digital Signature	Document Management	Master Data Repository
Benefits	Paper reduction	✓	✓	
	Agility	✓	✓	
	Displacement reduction	✓		
	Security	✓	✓	
	Availability	✓	✓	
	Interoperability	✓	✓	✓
	Data integrity	✓	✓	✓
	Better regulation			
	Document lifecycle optimized	✓	✓	
	Extensibility to the society	✓		
	Cost reduction	✓		
	Shorter deadlines			
	Shorter time to implement the projects			✓
	Statistics			✓

Table 8 – Benefits of System, Technical Platforms and Applications

5.1.1.3 Policies and IT Strategy

- **Electronic Judicial Administration Legislation:** A set of laws must provide legal support to the Electronic Judicial services. Some of the most important aspects that should be regulated are the following:
 - Rights and obligations for citizens, legal professionals and administrative bodies in the electronic judicial administration scope.
 - New civil servants duties.
 - Electronic Judicial Office. An electronic justice electronic one-stop-shop.
 - Digital Signature - used in electronic judicial administration.
 - Electronic Judicial File and Document regulation and definition.
 - Electronic copies management.



Improvement of the Enforcement system in the Republic of Croatia

Contract Number: 2010-01-23-010101

Twinning Number: HR/10/IB/JH/04

- ✎ Electronic archive for files and documents (both, paper and electronic based).
 - ✎ Electronic Judicial Registry.
 - ✎ Deadlines for electronic-based communications.
 - ✎ Electronic delivery, submission of claims and procedural documents and notifications.
 - ✎ Electronic board for official announcements and communications.
 - ✎ Electronic Case Management.
 - ✎ Interoperability with other stakeholders and administrations.
- **Electronic Signature Legislation:** Electronic Signature legislation must be adapted to the European Union Regulation. Last regulation in this field is the EU Regulation 910/2014 on electronic identification and trust services (eIDAS).
 - **Judicial Interoperability and Security Framework:** This framework should establish the minimum requirements related to information systems which must be ensured by all competent judicial institutions. These requirements should be developed through technical guide. The bases of this framework must be articulated according the Organizational-institutional, Semantic-Legal, Technical and Temporal dimensions. The first step should be the basic Framework definition. Once this step is completed, the Electronic Judicial Document and File definition should be addressed. This project is part of Scope B. For more detail about Judicial Interoperability and Security Framework see report 2.2.2, section 5.3.
 - **Documents Lifecycle:** Similar to the paper based situation, the electronic documents lifecycle must be controlled. Judicial documents have to be controlled and managed, to assure they are in compliance with requirements of the dimensions defined in the Interoperability and Security Judicial Framework.

ICT Strategy: Information and Communication Technology Strategy must be clear to be able to sort and schedule all the technical actions required in short, medium and long term. This strategy has as main goal to align the strategy of the Ministry of Justice with all the scheduled technical actions. The ICT Strategy should cover at least 3 years, and it should be considered as a live document that has to be reviewed and maintained. This strategy requires a plan that covers the application development plan, IT infrastructure plan, training plan, etc. All these plans should be aligned to achieve the strategic goals defined.

		Policies and IT Strategy				
		Electronic Judicial Administration Legislation	Electronic Signature Legislation	Judicial Interoperability and Security Framework	Documents Lifecycle	ICT Strategy
Benefits	Paper reduction	✓			✓	
	Agility				✓	
	Displacement reduction	✓				
	Security		✓			
	Availability					



	Interoperability			✓	✓	
	Data integrity				✓	
	Better regulation	✓	✓	✓		✓
	Document lifecycle optimized				✓	
	Extensibility to the society	✓				
	Cost reduction					✓
	Shorter deadlines	✓				
	Projects time to market reduction			✓	✓	✓
	Statistics					

Table 9 – Benefits of Policies and IT Strategy

5.1.1.4 Stakeholders

- **Empowering the external users:** to allow an electronic relationship between external users and the Justice Administration. A paperless relationship model is the big step to evolve from the current system to an Electronic Judicial Administration. External users are key stakeholders in this new paradigm, as they have to use the electronic services to send or receive the judicial electronic documents. Without their participation it is not possible to accomplish successfully the Electronic Judicial Administration Plan. And therefore “empower external users” project is related with most of the previous projects: eDelivery, regulation, digital signature, etc. and it is therefore important to have a detailed deployment plan for them, including all the awareness campaigns, expectations management, support, etc.

		Stakeholders
		Empower external users
Benefits	Paper reduction	✓
	Agility	✓
	Displacement reduction	✓
	Security	
	Availability	
	Interoperability	
	Data integrity	
	Better regulation	



	Document lifecycle optimized	
	Society extensibility	✓
	Extensibility to the society	✓
	Shorter deadlines	✓
	Projects time to market reduction	
	Statistics	

Table 10 – Benefits and Stakeholders

Carrying out the list of improvements described above will significantly enhance the Civil Enforcement proceedings, with more agile and more efficient courts thanks to paper reduction, electronic relationships and improvements of new platforms and systems. In addition, the legal regulatory aspects should be taken care of, including the Policies and IT Strategy action plan.

5.1.2 Benefit Analysis

The six areas of improvement detected in the previous activity 2.2.2 for the Civil Enforcement process in the Republic of Croatia are covered with these technical measures proposed in the Scope A. Those are:

- **Massive use of paper**, as services such as eFiling or e-Delivery allows avoiding the use of the paper from the beginning of judicial cycle.
- **E-Justice services organization**: All the e-Justice services should be grouped in an electronic judicial office, a one-stop-shop for external users that links users with the Justice Administration.
- **Digital Signature**: The use of digital signature by Justice Administration and external users would report many benefits as it provides the same legal value as a signed paper document. Also the secure code verification allows verifying the integrity and authenticity of a digital signed electronic document to be printed through a service published in the Electronic Judicial Office.
- **System integrations**: The integration of the services (e-Filing, e-delivery, etc...) with the Judicial Systems will provide a huge increase in productivity of the judicial users. Also, as these services may be offered through a web service interface, external users could integrate their own applications with the judicial ones.
- **Increased e-Justice services availability**: The electronic services would allow establishing a stronger and wider relationship between the Justice Administration and the external users. In this Scope eFiling, eDelivery Systems, Secure Code Verification and Judicial case Status are the most important.
- **Interoperability**: As new services and integrations arose, the interoperability is more necessary to align the organizations, processes and systems so they can work together in an effective way. The Enforcement process would take advantage of the interoperability, as the proceedings require data and documents exchange between many stakeholders.

On the other hand, the global benefits identified during the analysis are the following (each one has been detailed and traced with the projects described):



Improvement of the Enforcement system in the Republic of Croatia

Contract Number: 2010-01-23-010101

Twinning Number: HR/10/IB/JH/04

- **Paper reduction**, since electronic services reduce the use of paper as users are acquainted with the new electronic system. Like all other judicial proceedings, the enforcement process would take advantage of the electronic justice services and electronic documents and files. The combined use of this service will produce a significant paper reduction.
- **Agility**, related to reduction of the in-person court visits and shorter deadlines. By using electronic procedures the information is obtained and managed in more efficient way. As a consequence of this working model change, Justice Administration would be more agile. Just the use of eFiling would allow a professional to file a document at court from his/her office without paper, displacements, or waste time.
- **Displacement reduction**, since the electronic judicial administration, by definition, implies that most of procedures are electronic and Internet-enabled. Therefore in most of the cases it is not necessary to visit courts to take care of paperwork.
- **Security**, mostly due to the digital signature and the use of electronic documents. With electronic documents and digital signature, security of the transactions increases significantly. There is a risk of forging a hand signed documents, but this risk is reduced significantly with the most advanced public key based technology.
- **Availability**, as electronic judicial administration information is more accessible. Usually these kinds of services are available 24x7, it means available 24 hours a day during 7 days per week. This makes that courts opening hours do not limit information access.
- **Interoperability**, which is one of the most important when, developing an electronic justice administration. Many of the projects proposed in Scope A are oriented to patronize the Interoperability between systems. The use of services like eFiling, eDelivery, Digital Signature, etc boosts a better interoperability and makes possible the creation of new information exchanges because the data is now in a common “language” shared by all the systems.
- **Data integrity**, as digital signature assures that the information has not been changed. Also features like Document Management boosts that information exists once, in a centralized repository. This situation prevents the uncontrolled copies and leakage of information.
- **Better regulation**, which is necessary in order to give legal value to most of the actions proposed in this report.
- **Document lifecycle optimized** as with tools like the Enterprise Content Management, the Digital Signature, or the use of electronic documents the documents lifecycle is more efficient and in consequence the information is catalogued in a better way. For a complex organization it is really important to know what is happening with each document is each single moment. To control if a document is active, sent, archived, etc. in each moment, is something priceless for the organization.
- **Extensibility to the society**. This new relationship model based in electronic services needs to be communicated to the civil society and allow them to participate.
- **Cost reduction**, what is probably one of the main concerns of the IT and business departments. Ministry of Justice and Courts must consider the cost reduction as one of the main goals. Most of projects described in the Scope A are oriented to costs reduction by definition, as electronic services reduce total cost of the service. Electronic services require an initial investment but, the ROI (Return of Investment) use to be quick.



Improvement of the Enforcement system in the Republic of Croatia

Contract Number: 2010-01-23-010101

Twinning Number: HR/10/IB/JH/04

- **Shorter deadlines**, which is directly related to agility and displacement reduction, and indirectly with other benefits like cost reduction and paper reduction. It is possible through electronic services to get shorter deadlines in processing the court cases and, especially in the Enforcement proceedings as much information is exchanged quicker and in an automatic way. As there are no waiting times between sending/ mailing and deliveries because information can be send at the same time as it is generated and then the total time of the proceedings is reduced significantly.
- **Projects time to market reduction**, as the basic infrastructures of interoperability are created it is possible to reuse the same components to compound new electronic services and make them available quickly at the one-stop-shop. For example, once created the eFiling service for Enforcement processes, it is possible to reuse it for other scopes just by reusing the same component, with different destination in the ICMS.
- **Statistics**, what is a key benefit for the Ministry of Justice management board layer. The statistics allow measuring of the courts daily work. By use of the electronic services like eFiling, eDelivery, Digital Signature, etc. it is possible to have automatic measures of the defined key figures by the business layer. With this project on the table, Ministry of Justice should define the business key figures interesting for the organization in order to be implemented with different projects and have taken into account at the moment of development.



5.1.2.1 Scenario 1 – Enforcement over monetary assets

A creditor requests from FINA the enforcement over monetary assets. This process is handled by FINA except in case of opposition of the debtor, in which case the process goes back to court.

The use of e-justice service would provide a significant improvement in this process:

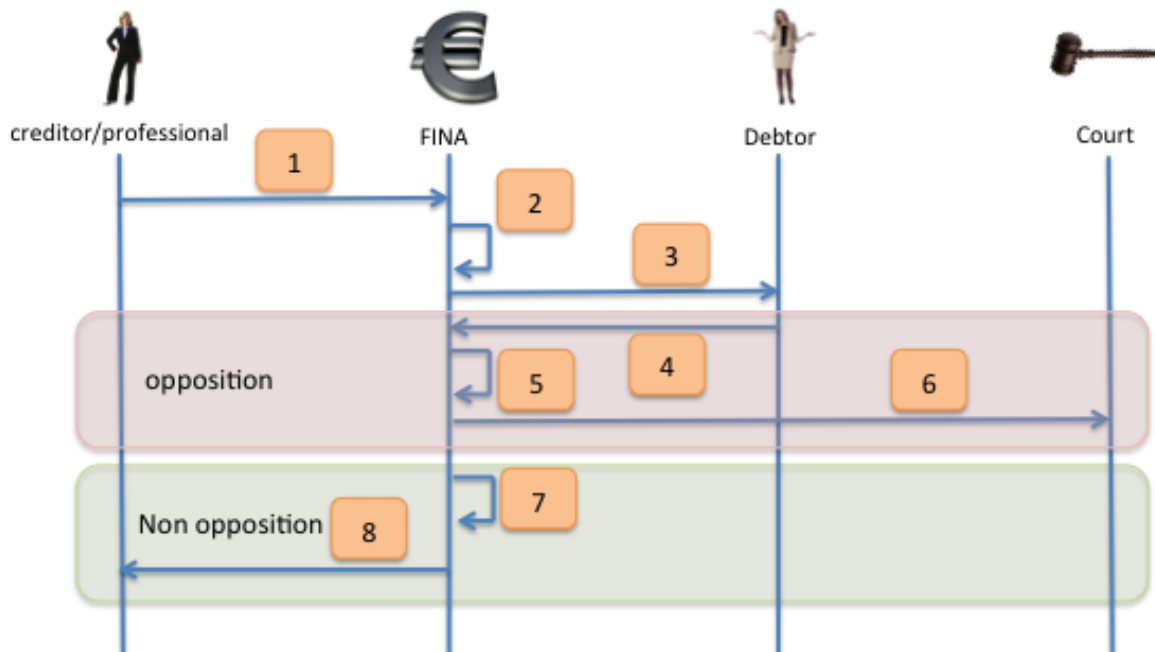

Illustration 11 – Scenario 1 - Enforcement over monetary assets

In steps 1, 3 and 6 the e-filing service would improve significantly the agility of the process by allowing to all the stakeholders of the scenario to submit the documentation electronically to FINA. The creditor/professional could file electronically the request to FINA, in case of opposition the debtor could send the information to FINA, and FINA would submit the enforcement file and the opposition information provided by the debtor to court. The e-filing service provides many benefits, such as **Paper reduction**. Since it is not necessary that the creditor/professional or debtor provides any documentation in paper form, it is not necessary to print documentation. Also, this system could report benefits to FINA, as it is not necessary for them to store physically the files submitted by parts. Also e-filing system prevents FINA to print the file and to send it to court in case of opposition. **Agility** is another key benefit of using this system, as the process is paperless, the deadlines would be adjusted to this situation: no documents movement between departments is required in FINA, the deadline for parts could be adjusted, reduction of the time that the file needs to get to court, etc.

This new paperless environment will be complemented with other benefits such as the **displacement reduction**. As the process will be available on the Internet, it won't be necessary to visit any FINA, Notary or court facility, saving time and money to the parts involved in the procedures.

All these benefits could be translated into cost reduction. The potential benefits has been estimated by taking into consideration the 2014 first semester statistical data and making a projection for a complete year. For the estimation model just the proceedings received has been taken into consideration and it has been made several assumptions for the model (Defined in the section 4.2 of this document).



- Paper reduction: Assuming that each year FINA receives almost 1.5 million of enforcements over monetary assets, considering the assumptions, it is estimated that it would involve more than 11 million of pages of paper. Just the cost of the paper, printing and storage of an enforcement requests is almost 6 million HRK each year. In addition, this cost will increase up 11.5 million HRK if cost of copies of the enforcement files is taken into consideration.

# Proceedings Received	# Paper Documents	# Pages	Cost of paper	# Enforcement Files Copies	Cost of Enforcement Files Copies
1.435.870	2.871.740	11.486.960	5.743.480,00kn	2.871.740	11.486.960,00kn

- Displacement reduction: As the “paperwork” could be done over the Internet, no displacement of creditor/professional or debtor is required. All the relationship with FINA/Court could be done from home/office, so there is transportation time required, adjusting to FINA/Courts opening hours, etc. Currently it has been modelled that for each proceeding, at least there is a visit of the professional/creditor to FINA to start the proceeding and that visit would take 30 minutes. Also the cost per hour has been calculated using the 2015 Croatian minimum wage published by Eurostat. When all this data is add together it brings up that the cost of visiting the FINA facilities in order to start the process exceeds 12 million HRK per year.

# Proceedings Received	# Court Visits	# Hours spent	FINA visits cost
1.435.870	1.435.870	717.935	12.237.528,41kn

In this scenario, in the steps 3 and 8 the **e-delivery** service and the **secure code verification** would provide a significant improvement, as it is no longer necessary that FINA prints notification documents and uses the postal system to perform the notifications. Also the generated documents for the e-delivery service should be digitally signed and stamped with secure code verification, so its integrity could be verified in case the document is printed. These systems will boost the benefits identified previously and will provide the functionality required to complete a 100% electronic relationship in the enforcement process on monetary assets. Regarding the cost reductions, the use of the e-delivery would save FINA almost 150 million HRK in notifications assuming 2 notifications per process and an average notification cost of 50 HRK per notification. For these estimations, only partial savings have been taking into consideration. In a deeper analysis, court savings should be added, increasing the total amount of savings.

# Proceedings Received	# Notifications	Notifications cost
1.435.870	2.871.740	143.587.000,00kn

So, adding up all the benefit and plotting them into an economic dimension, the total saving per year in the enforcement process over monetary assets would be **173 million HRK** per year for creditor/professional, debtor, FINA and courts. Economic dimension is just one dimension, in which the benefits should be measured, others dimension could be also taken into consideration such as: citizens’ satisfaction with judicial service, increased proceedings resolution ratio, OPEX optimization, etc.



5.1.2.2 Scenario 2 – Enforcement on immovable

In this scenario the creditor/professional files an enforcement request to implement enforcement over an immovable asset that should be auctioned by FINA.

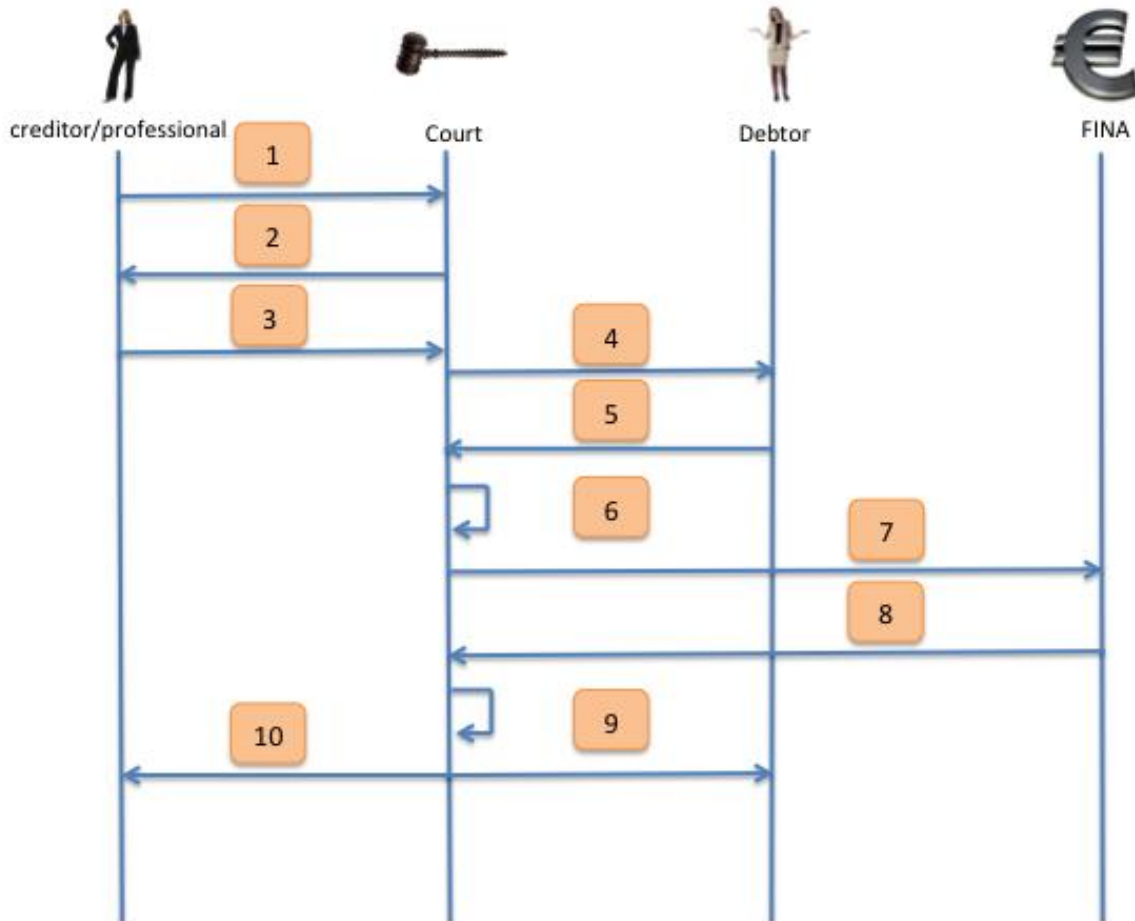

Illustration 12 – Scenario 2 – Enforcement on immovable

For this case, all scope A e-Justice services will be used (e-filing, e-delivery, Secure Verification Code and Judicial File Status). The main benefits of the combine use of this system are evidenced by significant paper reduction, increase of the agility of the procedure, avoiding unnecessary visits to the court facilities, availability of updated information regarding the procedure and cost saving.

Both services, **Secure Verification Code** and **Judicial File Status**, could be in use during most of the life cycle of the procedure. The first one would be used to verify all the documents generated by court or FINA. The Judicial File Status will be available from step 3, as the enforcement request gets filed and a new procedure begins. Regarding the **e-filing** service, this service is used in the steps 1, 3, 5 and 7, and the **e-delivery** service would take place in the steps 2, 4, 8 and 10. The use of these services is intense and the impact on the enforcement proceeding is significant.

As it has been done in the previous scenario, the benefits of using e-justice services in enforcement on immovable assets have been analysed from an economic perspective. For this purpose, the 2014 first semester statistical data has been used. With this data a complete year projection has been done. For the



estimation model just the proceedings received for immovable assets has been taken into consideration and several assumptions have been made for the model. (Defined in section 4.2 of this document).

- Paper reduction.** In terms of paper reduction, assuming the receiving of 16.182 requests for immovable enforcement per year, the use of e-justice services would save more than 1.5 paper pages with an estimated cost of 809.100 HRK. Adding this savings to the savings of suppressing the copy of the files in paper (1.6 million of HRK), it throws a total saving in paper of almost 2.5 million HRK per year.

	# Proceedings Received	# Paper Documents	# Pages	Cost of paper	# Judicial Files Copies	Cost of Judicial Files Copies
Immovable assets	16.182	161.820	1.618.200	809.100,00kn	32.364	1.618.200,00kn
Monetary Claims	76.810	768.100	7.681.000	3.840.500,00kn	153.620	7.681.000,00kn
Movables	18.412	184.120	1.841.200	920.600,00kn	36.824	1.841.200,00kn
Other	15.838	158.380	1.583.800	791.900,00kn	31.676	1.583.800,00kn
Total	127.242	1.272.420	12.724.200	6.362.100,00kn	254.484	12.724.200,00kn

- Displacement reduction.** The use of the e-justice services would also reduce the amount of time that parts should use to visit the court. In case of the of immovable enforcement proceedings the amount of hours saves sums 48.546 hours and more than 800.000 HRK.

	# Proceedings Received	# Court Visits	# hours spent	Court visits cost
Immovable assets	16.182	48.546	48.546	827.488,64kn
Monetary Claims	76.810	230.430	230.430	3.927.784,09kn
movables	18.412	55.236	55.236	941.522,73kn
Other	15.838	47.514	47.514	809.897,73kn
Total	127.242	381.726	381.726	6.506.693,18kn

- Notifications.** The use of e-delivery services avoids the use of paper and regular mail, and also provides high value service which may reduce the judicial deadlines significantly. The total savings for the notifications of the parts involved in immovable enforcement proceedings are bigger than 4.5 million HRK per year.

	# Proceedings Received	# Notifications	Notifications cost
Immovable assets	16.182	97.092	4.854.600,00kn
Monetary Claims	76.810	460.860	23.043.000,00kn
movables	18.412	110.472	5.523.600,00kn
Other	15.838	95.028	4.751.400,00kn
Total	127.242	763.452	38.172.600,00kn

The total saving on this scenario rises to **8 million HRK**. This amount increases up to **63 million HRK** if all the types of enforcement are taken into consideration.



If both scenarios estimations are added (1 and 2), it gives a total saving of **236 million HRK** per year for the stakeholders of the enforcement proceedings: Creditor/professional, Courts, FINA and Debtors. With this figure in mind, the return of the investment required to provide real eJustice services would justify the projects. However, the economical aspect is not the only one that should be taken into consideration. There are other high values, such as citizen-friendliness, efficiency, control over the proceedings and time reduction in judicial matters.

5.1.3 Costs Analysis

This section will analyse the Scope A costs, in terms of hours of development. The effort includes neither the deployment cost nor the organizational tasks that should be done, such as training of court staff.

The effort has been distributed from a program/project management point of view. In the execution of the project, the standard project development phases have been included: analyse, design and development. The deployment and maintenance phases have not been estimated as depended of external factors, which currently cannot be measured. The estimations have been done on the basis of Spanish experience.

The Ministry of Justice has provided a resume table of the ongoing or planned projects. Most of these projects would be founded with the IPA 2012 “Further improvement of case management system (e-Spis)”. This IPA is founded with a total of 6.600.000 EUR (2.000.000 EUR for technical assistant and 4.600.000 EUR for equipment).

The purpose of the IPA project is strengthening the efficiency of the judiciary, judicial staff productivity, and enabling better management capacity of the courts within the Ministry of Justice by establishing a reliable, efficient and sustainable management system, and strengthening the administrative capacity of the courts and purchase of IT equipment.

With this in mind, many of the scope A projects proposed are covered in this IPA project and could be founded. The projects under this situation have not been cost estimated. Also the pure law-related projects are not estimated as it is out of the scope of this technical report.

		Scope A	Status
Electronic Services	eFiling	✓	IPA 2012
	eDelivery	✓	IPA 2012
	Secure Code Verification	✓	Implemented in Land Registry application
	Judicial Case Status	✓	Implemented in e-Spis
Systems, Technical Platforms and Applications	Digital Signature	✓	IPA 2012
	Document Management	✓	IPA 2012
	Master Data Repository	✓	n/a
Policies and IT Strategy	Electronic Judicial Administration Legislation	✓	Some items are regulated under Criminal and Civil Law but don't have unique Law on Electronic Judicial Administration
	Electronic Signature Legislation	✓	Law on Electronic Signature is in force, changes are



Improvement of the Enforcement system in the Republic of Croatia

Contract Number: 2010-01-23-010101

Twinning Number: HR/10/IB/JH/04

			planned due to EIDAS
	Judicial Interoperability and Security Framework	✓	In strategy, no planned project
	Documents Lifecycle	✓	In strategy, should be defined for IPA 2012
	ICT Strategy	✓	Project planned in 2015
Stakeholders	Empower external users	✓	Under consideration

Table 13 – Scope A project status

- **eFiling:** this project is included in IPA2012 in “ Further improvement of case management system (e-Spis)” project.
- **eDelivery:** this project is included in IPA2012 in “ Further improvement of case management system (e-Spis)” project.
- **Secure Code Verification:** the scope of the analysis is a centralized system, which is able to generate the codes and make them available to Ministry of Justice applications. Also, the connection with a document management system is included. The task needed to adapt each application to consume the secure verification code service is not included in this estimation.

Project name	Secure Code Verification					
Estimated effort (in hours)						
Profiles	Phases					Totals per profile
	Initiation	Planning	Executing	Management & Control	Closure	
Program manager	2,6	15,6	23,4	7,8	2,6	52
Project manager	25	150	225	75	25	500
Architect			104			104
Business analyst			240			240
IT Consultant			130			130
Programmer			800			800
Totals per phase	27,6	165,6	1522,4	82,8	27,6	1826
Distribution	1,51%	9,07%	83,37%	4,53%	1,51%	100,00%

- **Judicial Case Status:** already implemented in e-Spis.
- **Digital Signature:** this project is included in IPA2012 in “Further improvement of case management system (e-Spis)” project.
- **Document Management:** this project is included in IPA2012 in “Further improvement of case management system (e-Spis)” project.
- **Master Data Repository:** This project should be divided in phases, and because of that it has only been estimated the initial phase- to build the main structure with the most important data: courts



Improvement of the Enforcement system in the Republic of Croatia

Contract Number: 2010-01-23-010101

Twinning Number: HR/10/IB/JH/04

codifications, police office codifications, registries codifications, legal professionals registry, etc. which is the most important metadata necessary for interoperability. In this project a decision should be made: DO or BUY. Based on Spanish experience, the developing time has been estimated.

Project name	Master Data Repository					
Estimated effort (in hours)						
Profiles	Phases					Totals per profile
	Initiation	Planning	Executing	Management & Control	Closure	
Program manager	6	36	54	18	6	120
Project manager	50	300	450	150	50	1000
Architect			200			200
Business analyst			416			416
IT Consultant			416			416
Programmer			1248			1248
Totals per phase	56	336	2784	168	56	3400
Distribution	1,65%	9,88%	81,88%	4,94%	1,65%	100,00%

- Electronic Judicial Administration Legislation:** Although this project is tightly related to ICT aspects, it is a “legal project”. Therefore cannot be estimated like a technological project and also because legal and organizational flows in the Ministry of Justice are unknown. However, it is essential to involve high-level technological staff in this project.
- Electronic Signature Legislation:** Applies the same that “Electronic Judicial Administration Legislation”.
- Judicial Interoperability and Security Framework:** like the master data repository project, this project should be faced in phases. A definition of this project is done in previous report 2.2.2. The scope of this analysis is to create the first version of the framework, which at least includes: Interoperability and Security Basics, Digital Signature Policy, Security Guide and an Organizational Interoperability Action Plan.

Project name	Judicial Interoperability and Security Framework					
Estimated effort (in hours)						
Profiles	Phases					Totals per profile
	Initiation	Planning	Executing	Management & Control	Closure	
Program manager	32	192	288	96	32	640
Project manager	96	576	864	288	96	1920
Architect						0
Business analyst			2560			2560
IT Consultant			1280			1280



Improvement of the Enforcement system in the Republic of Croatia

Contract Number: 2010-01-23-010101

Twinning Number: HR/10/IB/JH/04

Programmer						0
Totals per phase	128	768	4992	384	128	6400
Distribution	2,00%	12,00%	78,00%	6,00%	2,00%	100,00%

- **Documents Lifecycle:** this project is included in IPA2012 in “Further improvement of case management system (e-Spis)” project.
- **ICT Strategy:** this project scope includes definition of a complete ICT strategy, MoJ strategic goals definition, and all the required plans to achieve them. It should include, at least, the following plans:
 - Applications Development Plan.
 - IT Infrastructure Plan.
 - Applications Deployment Plan.
 - Procurement Plan.
 - Training Plan.
 - Support and Maintenance Plan.
 - Etc.

Project name	ICT Strategy					
Estimated effort (in hours)						
Profiles	Phases					Totals per profile
	Initiation	Planning	Executing	Management & Control	Closure	
Program manager	7,8	46,8	70,2	23,4	7,8	156
Project manager	39	234	351	117	39	780
Architect			104			104
Business analyst			832			832
IT Consultant			1664			1664
Programmer						0
Totals per phase	46,8	280,8	3021,2	140,4	46,8	3536
Distribution	1,32%	7,94%	85,44%	3,97%	1,32%	100,00 %



- **Empower external users:** this is not a technological project, and because of that has not been estimated. The only technological task identified in this project is the mailboxes creation for citizens and legal professionals involved in the scope. This project should, at least, include active actions like:
 - Dissemination seminars for legal professionals.
 - Awareness campaign for legal professionals.
 - Dissemination material for citizens.



Improvement of the Enforcement system in the Republic of Croatia

Contract Number: 2010-01-23-010101









Twinning Number: HR/10/IB/JH/04

-  Collaboration agreement with public administrations.
-  Technological support to chambers of professionals /bar associations.

5.2 Scope B Analysis

In this case, **Scope B covers advanced aspects to improve the judicial system** from a deeper IT point of view, and of course including the Enforcement process. As it is stated previously in this document, scope B is going to be explained from projects point of view, but not analysed in deep.

The goal of this scope is to achieve the maximum set of capabilities that guaranties an electronic judicial system able to offer electronic services aimed not only to internal users of IT departments, but also to courts, citizens and legal professionals. Most of them are advanced items that improve/include new electronic services, technical platforms and applications, and some policies and stakeholders. Those are:

-  **Electronic Services** (citizens and legal professionals focused)
 -  **eFile Access:** in the scope A it is possible to access to the case status but with this new service it is possible to grant access to the parts of the file case and download electronic copies if authorized.
 -  **eAuctions:** this is an advanced service for citizens and professionals, having the chance to bid from their own computers. For this electronic service, it is very important to solve interoperability issues in advance. The ICMS and other needed systems should be connected with eAuctions system, in order to exchange information and make automatic announcements and implementation of auctions.
-  **Systems, Technical Platforms and Applications** (IT department focused)
 -  **Electronic Judicial File and Document:** in the scope A, the Judicial Interoperability and Security Framework have been covered. Therefore the Scope B covers development of the next step: detailed definitions for Electronic Judicial Documents and Files. An electronic document is not only a PDF or Word document, but also could include video, sound or others file formats. A real Electronic Judicial Document is described, at least, with metadata, content and digital signatures.
 -  **Identity Management:** Once a complete judicial electronic administration is working, it is really complex to manage users' digital identities and applications permissions, due the huge volume of them. The need of digital id management systems requires an identity management system with, at least, a minimum set of features for users and permissions management (create, delete and modify).
 -  **Business Process Management:** this platform is recommended only for matured electronic justice administrations as it implies to model the judicial processes in detail and then to implement them in a specialized tool. The benefits obtained are more oriented to court users and IT procedures. Citizens and legal professionals don't have to deal with the complexity of judicial internal activity, so this system it is not required for them at first stage.
 -  **Digitizing and Cataloguing System:** the reduction of use of paper is the final goal that every electronic justice administration pursues. Therefore once the basic processes and systems





Improvement of the Enforcement system in the Republic of Croatia

Contract Number: 2010-01-23-010101

Twinning Number: HR/10/IB/JH/04

are running, the next step is to eliminate the rest of paper received in courts. In most cases it is not possible to force to citizens to full use of the electronic services due the current European regulation. Therefore, it should be deployed a system capable to digitalize, cataloguing and archive the received paper and incorporate them as electronic documents to the system. This should be the last stage of the dropping of paper process.

Policies and IT Strategy (Organization focused)



-  **Judicial Business Flows:** The purpose of this project is to model the judicial procedures flows with the aim to be implemented in a BPM tool. This is not a technological process, but it is directly related with the Business Process Management project: the first step is to model the process and the second step would be the BPM implementation. This is a time consumer activity but it is really important as it is a fundamental prerequisite for the process implementation. The judicial business flow analysis and design process also should include the required milestones and key indicator that would enable to measure the processes when they are executed.
-  **Identity Policy:** it is related to Identity management system. This system has to cover all the court staff identity requirements such as permissions, HR structure, etc. This system will help to determine, by business rules, what permissions are granted to the user based in his/her organizational position, to define the flows for new court users, etc.

Stakeholders (Third party focused)

-  **New key stakeholders:** This project deals with the incorporation of new users to the electronic eJustice ecosystem. In the Scope A it has been achieved to empower the current or most regular users: lawyers, bailiffs, etc but at this point the rest of them should be incorporated. This new users could have relationships with courts. It is recommended to have different phases in order to have a controlled process of incorporation of users.

Carrying out this list of projects, the Scope A is enhanced to achieve an advanced Electronic Justice Administration capable to improve significantly the Civil Enforcement Process in the Republic of Croatia. With the first Scope courts will be more agile and more efficient thanks to paper reduction, electronic relationships and platforms/systems improvements. With this second one, auctions will be executed by electronic means, it will be possible to access to the documents of files through Internet, and most of core platforms will be enhanced significantly.

The six areas of improvement detected in the previous activity 2.2.2 for the Civil Enforcement process in the Republic of Croatia are covered with these technical measures proposed in the Scope B. Those are the following:

-  **Massive use of paper,** since the parts would have eFile access, auctions would be conducted by electronic means, and the incorporation of all users able to have relations with courts at any time. Also digitalize and cataloguing system plays an important role in this scope, as it is the way to eliminate the paper definitely from the Justice Administration.
-  **E-Justice services organization:** because new electronic services are born in the Electronic Legal Office and all of them are grouped in the judicial one-stop-shop.
-  **Digital Signature:** due to the incorporation of all the users involved in the Enforcement, and as they would use electronic services to interact with the Judicial Administration, the digital signature should be massively used and therefore the flow of documents is more controlled.



Improvement of the Enforcement system in the Republic of Croatia

Contract Number: 2010-01-23-010101

Twinning Number: HR/10/IB/JH/04

- **System integrations:** in the scope B, all integrations should be on service. These integrations have to fulfil the interoperability requirements. It is essential to have an Electronic Judicial Document and File definition in order to assure the full integration of systems.
- **Increase e-Justice services availability:** in this Scope B, at least eFile access and eAuctions are added to Electronic Judicial services ecosystem.
- **Interoperability:** the benefit of the automatic data and documents exchange between applications and systems is really significant. In the Scope B it is even more important as advanced and specialized tools appears in the ecosystem such BPM, ID Management, etc. In this point is absolutely necessary that the definition of Electronic Judicial Document and File is mature.

6 Conclusions

- The use of e-Justice services implies a radical change of the way how Justice Administration interacts with citizens, legal professionals, companies and other public administration bodies. Furthermore, this change of paradigm also affects the Justice Administration work system, changing the current model based in paper files, use of mail and in-court paperwork to a new model based on electronic documents and files, data-oriented and Internet-enabled services.
- The benefits of the effective deployment of new e-Justice services and systems imply a significant improvement in the Croatian Enforcement system. This benefits can be measured in several dimensions, such as:
 - **Functional:** e-Justice services change the relationship model towards a citizen-and companies-oriented justice. The justice users are empowered, so they can establish a completely different relationship model with the Justice Administration. With the implementation of a real e-Justice, the Administration of Justice would become a key driver of innovation for the whole Croatian Public Administration.
 - **Economic:** The change of the current enforcement model requires large investments to develop new systems, to develop adequate IT infrastructure, to train the courts staff, etc. Most of the projects identified in scope A would be covered with IPA 2012 and the remaining projects require an estimated development effort estimated in around 2.000 man/days. Despite this important investment required, there are important compensations. It has been estimated that applying e-justice services to the civil enforcement could save 236 million of HRK per year in two defined scenarios, so the return of investment is clearly justified
- An innovative Justice improvement would allow providing new services to other Croatian public administrations and private sector, so they could deliver public services based on cost-effective, internet enabled, agile, secure, high quality and citizens-oriented that would boost not only the enforcement or the Justice administration, but also economic sectors.